



# 27-8CP11

# INSTRUCTION MANUAL

UNIVERSAL MULTIMEDIA ADAPTER  
CARPLAY/ANDROID AUTO/ MIRRORING

# CONTENTS

<b>FEATURES .....</b>	<b>5</b>
<b>SPECIFICATIONS.....</b>	<b>6</b>
<b>PACKAGE COMPONENTS.....</b>	<b>7</b>
<b>CONNECTION DIAGRAM .....</b>	<b>8</b>
<b>MAIN MENU UI .....</b>	<b>9</b>
<b>HOW TO CONNECT BLUETOOTH.....</b>	<b>10</b>
<b>APPLE CARPLAY .....</b>	<b>11</b>
<b>ANDROID AUTO.....</b>	<b>12</b>
<b>SCREEN MIRRORING.....</b>	<b>13</b>
<b>iOS .....</b>	<b>13</b>
<b>Android.....</b>	<b>13</b>
<b>USB STORAGE MUSIC &amp; VIDEO .....</b>	<b>14</b>
<b>SETTINGS.....</b>	<b>15</b>
<b>Start CarPlay/Android Auto Automatically .....</b>	<b>15</b>
<b>Car Setting .....</b>	<b>15</b>
<b>Touch Calibration .....</b>	<b>16</b>
<b>Display .....</b>	<b>16</b>
<b>Sound .....</b>	<b>17</b>
<b>Language.....</b>	<b>18</b>
<b>Wallpaper .....</b>	<b>18</b>

---

## WARNING

In order to protect the driving safety and avoid break the traffic law; please DO NOT operate the interface while driving.

The reversing surveillance function just is used in reversing assistance. Please check the entire surroundings while reversing.

All steps of installation should be done by the well-trained specialist.

During installation, the ignition key should be taken off and after all installation finished, connect power cable last.

Please DO NOT plug or pull the connected cables in the state of power-on, in order to avoid damaged monitor or accessory.

Install wiring in a manner in which cables will not come in contact with metal parts. The wiring may be damaged by contact with metal parts, resulting in fire and shocks. Avoid all contact with hot surfaces when wiring the main unit. High temperatures may damage wiring, causing shorts, arcing and fires.

Please DO NOT put the product in the damp environment or water, in order to avoid electric shock, damaged and fire accident caused by a short circuit.

Kindly check all components are in the box when receiving the product. If anything missing, inform to the supplier/manufacturer.

Start the engine before loading, check the interface whether have function displayed, key control whether correct, the vehicle interface whether having a scratch. Please give the feedback to the supplier/manufacturer if there have any questions.

Please note that put the disassembled automotive components in a good way on the installation process, avoid scratching the instrument panel, the leftovers of connecting cables need to handle and DO NOT leave it in the car. The connecting plug must be insulated in order to short circuit.

The cables should be connected in a good way, the vehicle installation space is a little small, so reduce space usage as far as possible. There should be a good plan about connect cables, avoid affecting the active component of connecting, such as control components of turning the steering wheel, throttle and brake pedal. There need to be fastened after connecting cables in case of a drop.

---

## FEATURES

Integrated 3 in 1 module supports wireless CarPlay, wired Android Auto, and USB cable screen mirroring (iOS & Android)

Support USB HD video (up to 1080P) and lossless music (APE, WAV, FLAC, MP3, WMA, etc) playback

CVBS and HDMI (480P/720P) output

Support AHD cameras input

Automatic enable CarPlay/Android Auto when connecting an iPhone/Android phone

High-performance audio output and support control sound volume, EQ settings

Provide an external knob controller for operation

Support installing resistive touch panel (sold separately)

Offer high-quality microphone for phone talking & voice command

Mobile phone charging

Further software update via USB

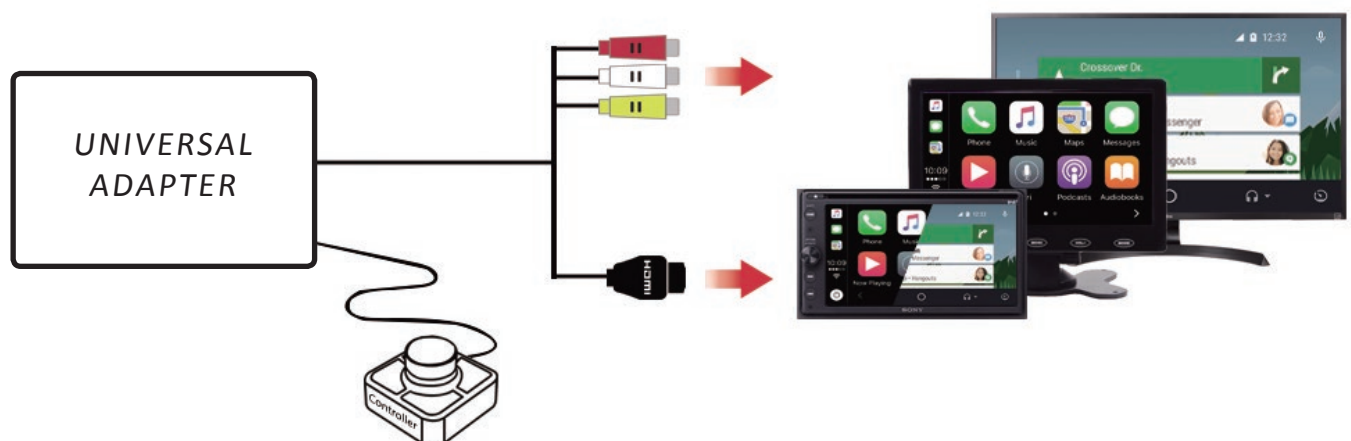

# SPECIFICATIONS

<b>Inputs</b>	RCA*2 (1 rear camera & 1 external video in, support AHD cameras) 3.5mm AUX*1 (microphone) USB*2
<b>Outputs</b>	RCA*3 (CVBS & audio L/R outputs) HDMI*1
<b>Output resolution</b>	CVBS: 720*480, NTSC HDMI: 800*480 (default), 1280*720 (optional, upgrade via software)
<b>Input voltage</b>	9-16V
<b>Consumed power</b>	5W
<b>Working temperature</b>	-20°C~75°C
<b>Main unit dimensions</b>	110*75*30 mm
<b>Weight</b>	170g



For any car/monitor with HDMI or RCA AV input.

# PACKAGE COMPONENTS

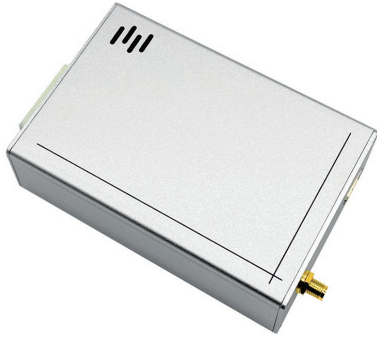

Main Unit



Power Cable



Touch/Video Cable



Microphone



Knob Controller

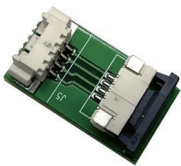

Resistive Touch Connection Board



WiFi/BT Antenna



Sticker for Knob Controller

# CONNECTION DIAGRAM

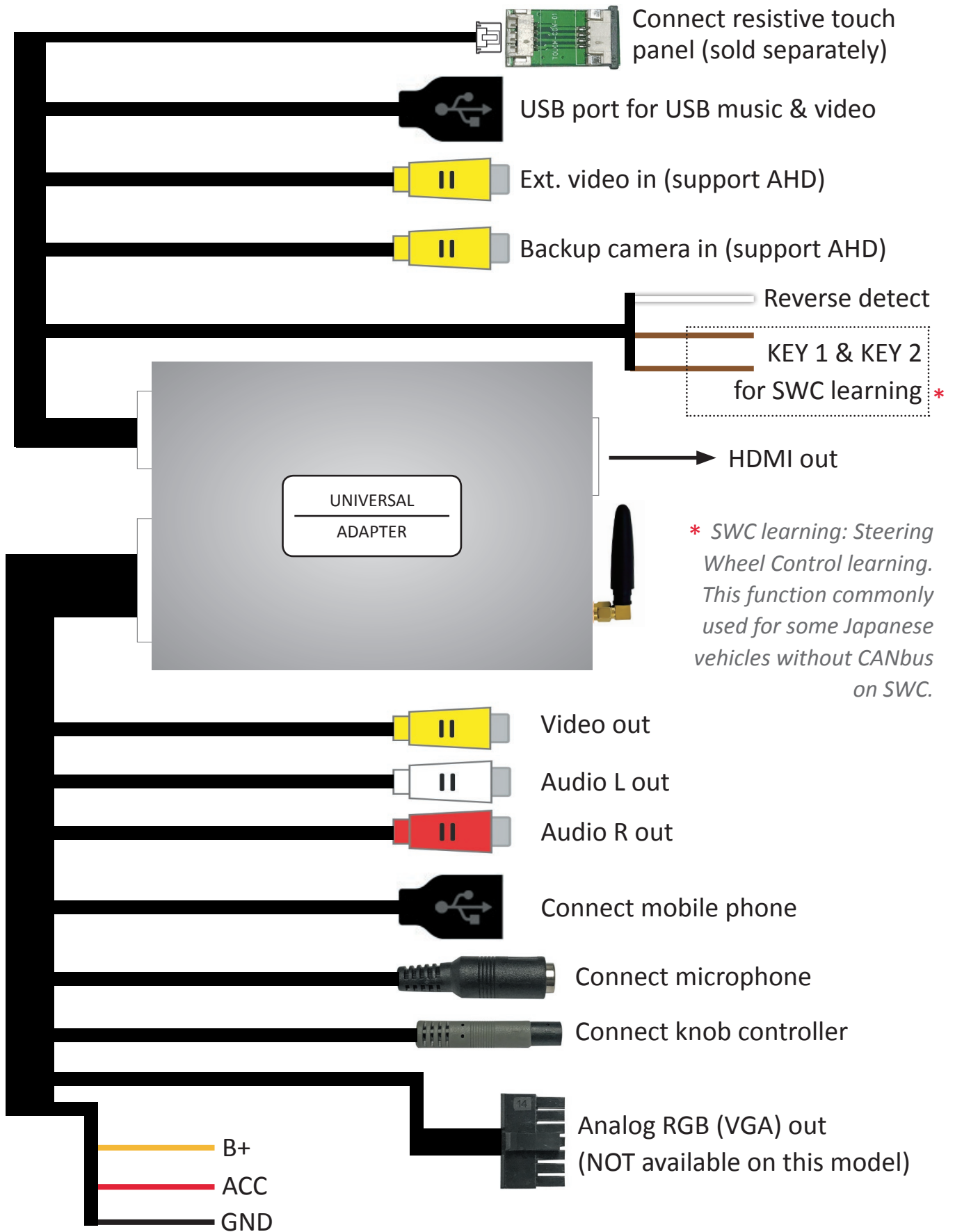

# MAIN MENU UI

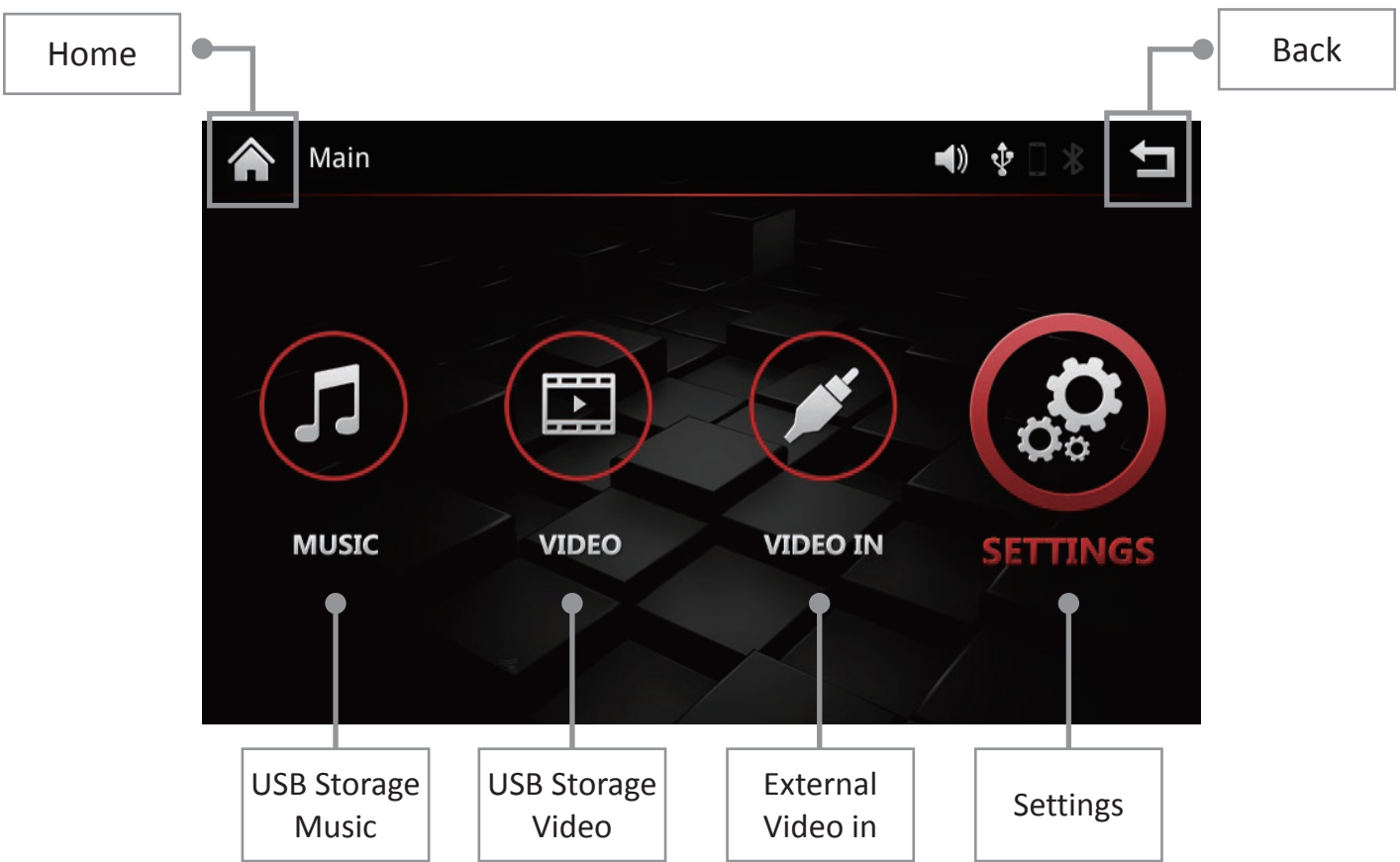
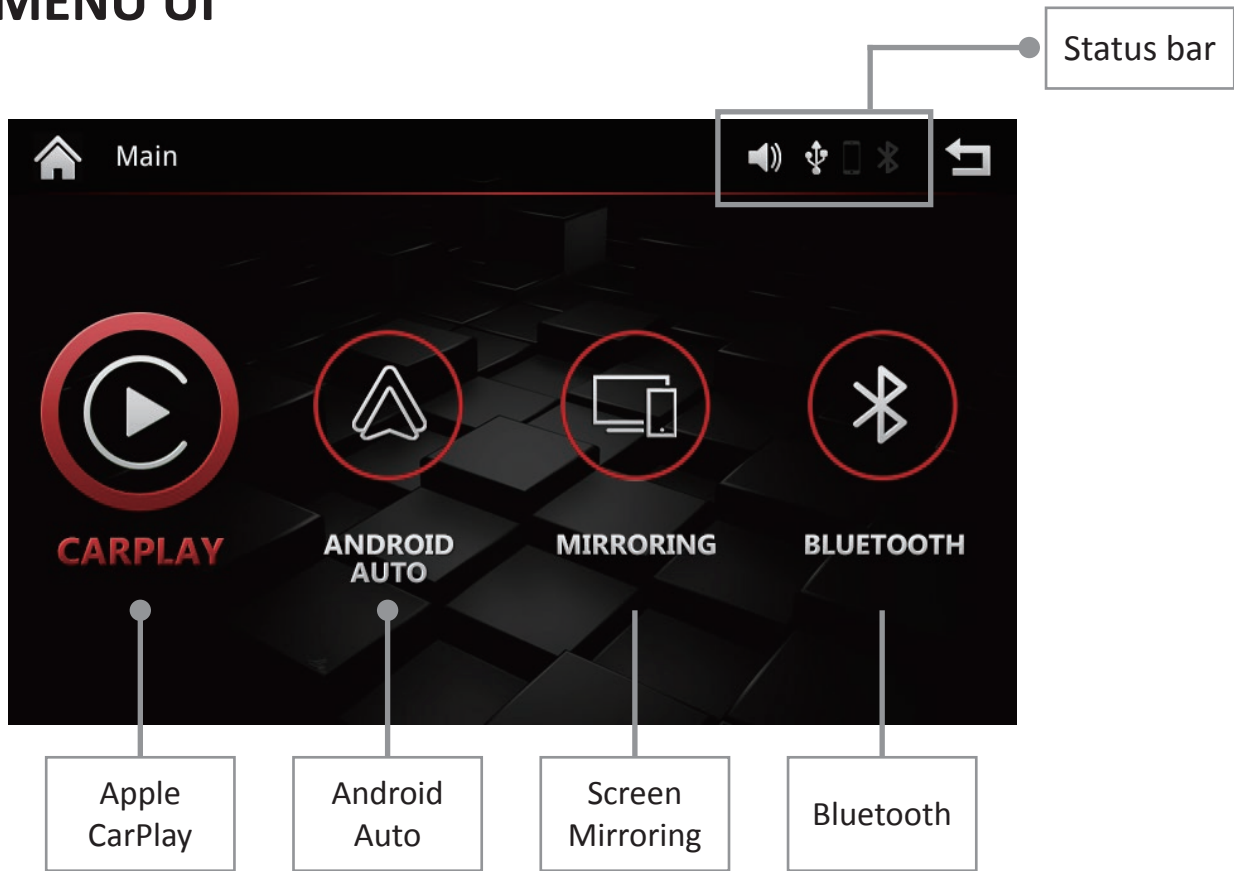



# HOW TO CONNECT BLUETOOTH

**Device name:** Car.Audio\_ xxxx

1. Turn on the mobile phone's Bluetooth, search and pair BT device **Car.Audio\_ xxxx**.
2. Tap "**Pair**" on the pop-up pairing request notification.
3. Tap "**Allow**" for sync contacts and favorites.

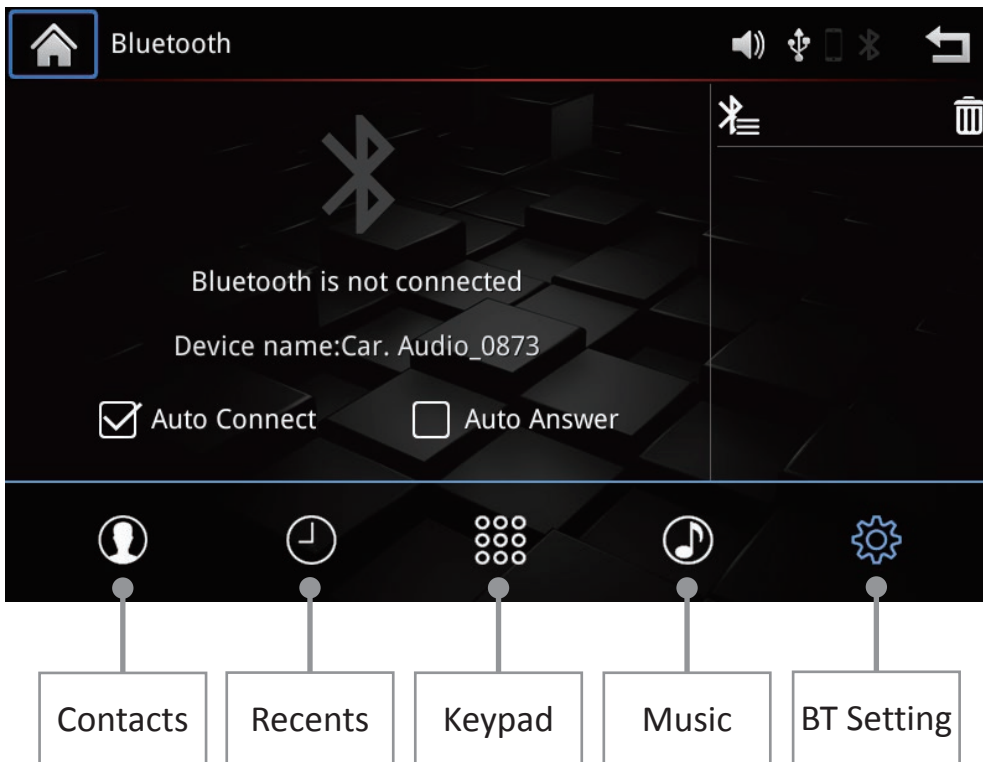

**Tick Auto Connect:** mobile phone connects Bluetooth automatically after starting the adapter

**Tick Auto Answer :** Accept calling automatically

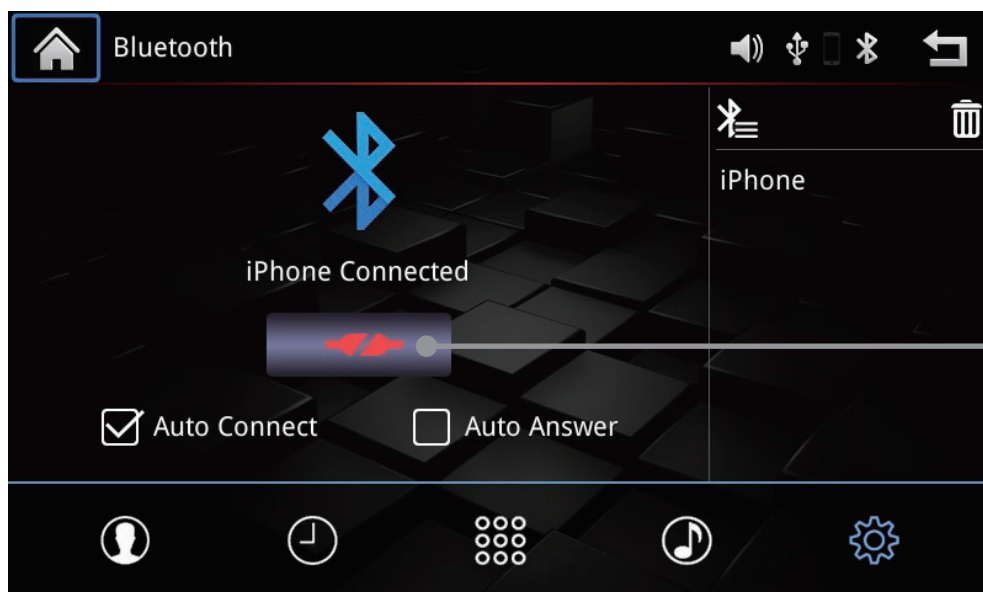

Delete all paired device

Disconnect BT

# APPLE CARPLAY

1. Turn on the iPhone's **WiFi and Bluetooth**, search and pair BT device **Car.Audio\_ xxxx**.
2. Tap "**Pair**", "**Allow**", "**Use CarPlay**" on the next 3 pop-up notifications.

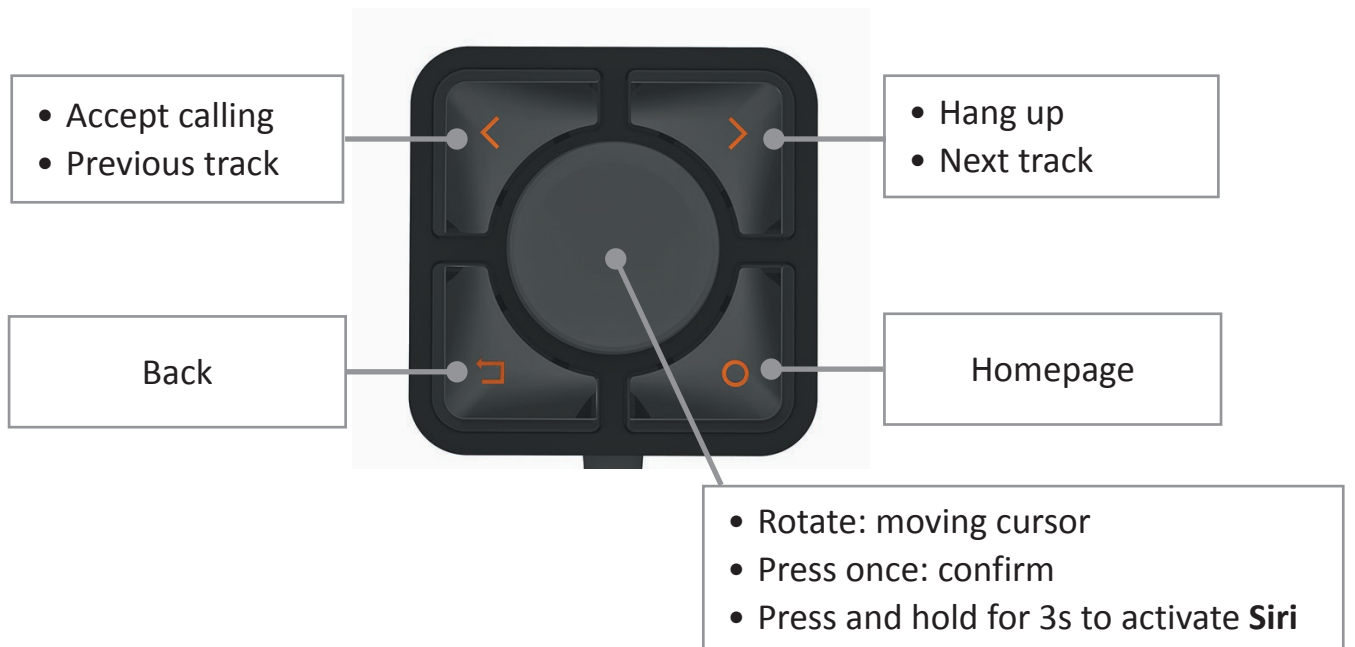
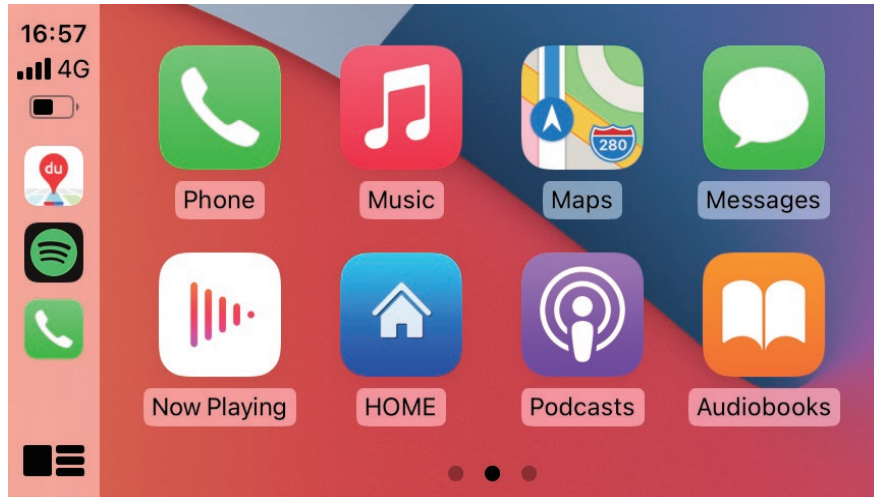
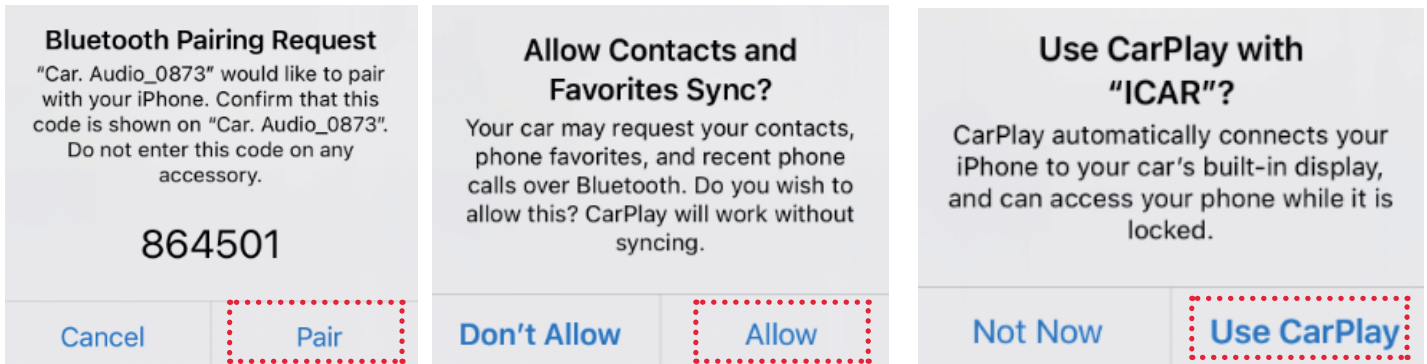

# ANDROID AUTO

1. Install Android Auto app on your Android smartphone.
2. Connect to universal adapter's Bluetooth.
3. Select and enter "**ANDROID AUTO**" icon of adapter.
4. Plug in the smartphone with USB cable (connect to the USB port of power cable).

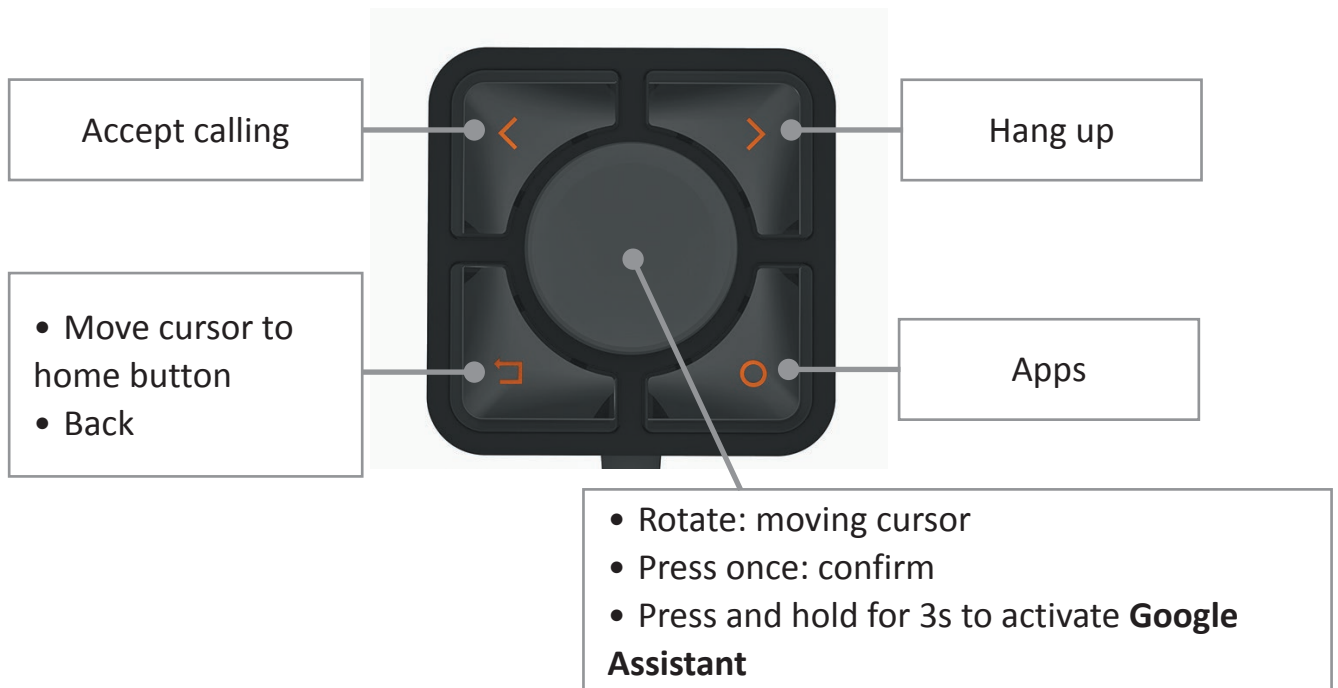
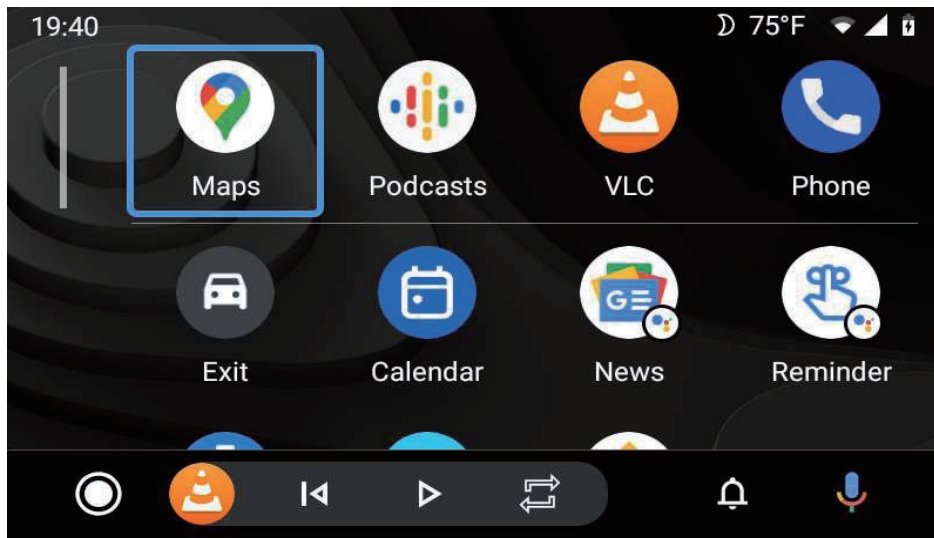

## NOTE!

- For the better connection performance, please use the original genuine USB cable.
- Knob controller functions may slightly differ depending on the Android Auto app version.

---

## SCREEN MIRRORING

### ● iOS

1. Select and enter "**MIRRORING**" icon of adapter.
2. Plug in the iOS device with USB cable (connect to the USB port of power cable).
3. Open iOS **Control Center**, tap "**Screen Mirroring**" icon, then tap **Mirroring**.

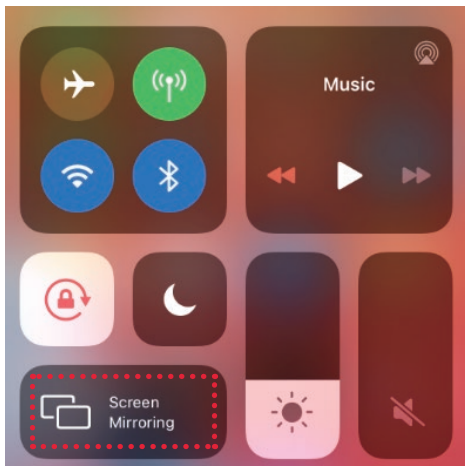

### ● Android

1. Enable "**USB debugging**" on Android phone's developer options.
2. Connect to universal adapter's Bluetooth.
3. Select and enter "**MIRRORING**" icon of adapter.
4. Plug in the Android device with USB cable (connect to the USB port of power cable).
5. Tap "**Allow**" on the pop-up notification.

**NOTE!** For the better connection performance, please use the original genuine USB cable.

# USB STORAGE MUSIC & VIDEO

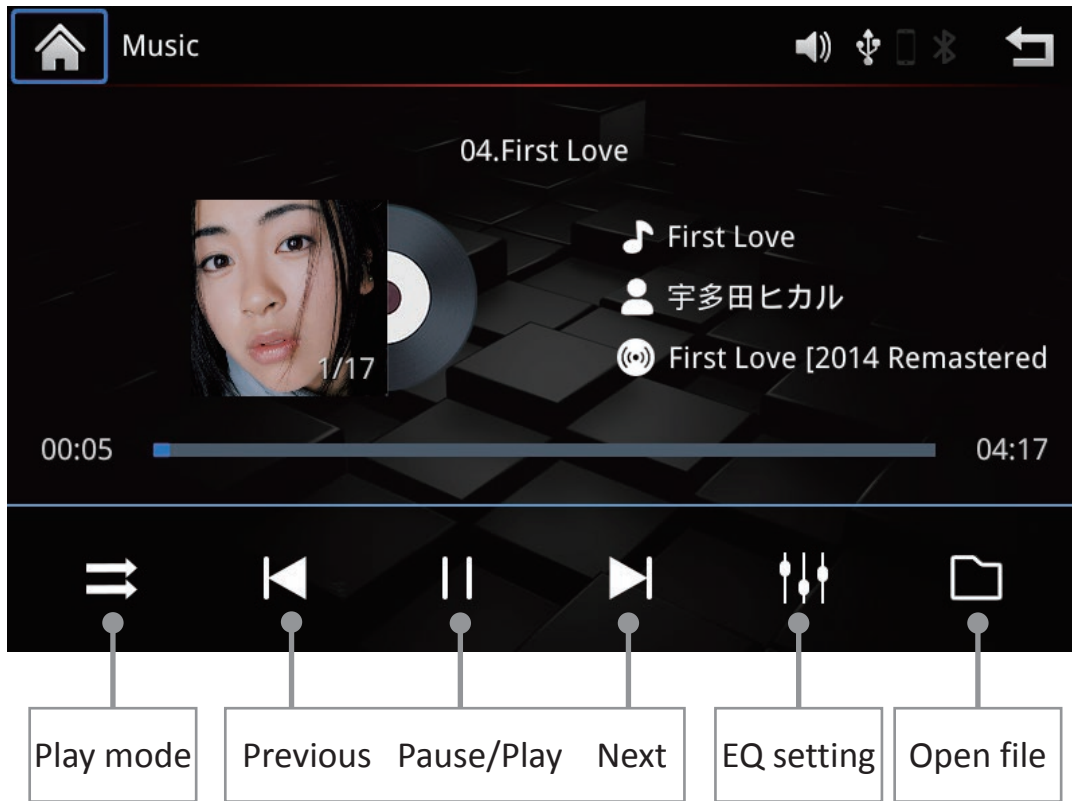

# SETTINGS

- **START CARPLAY/ANDROID AUTO AUTOMATICALLY**

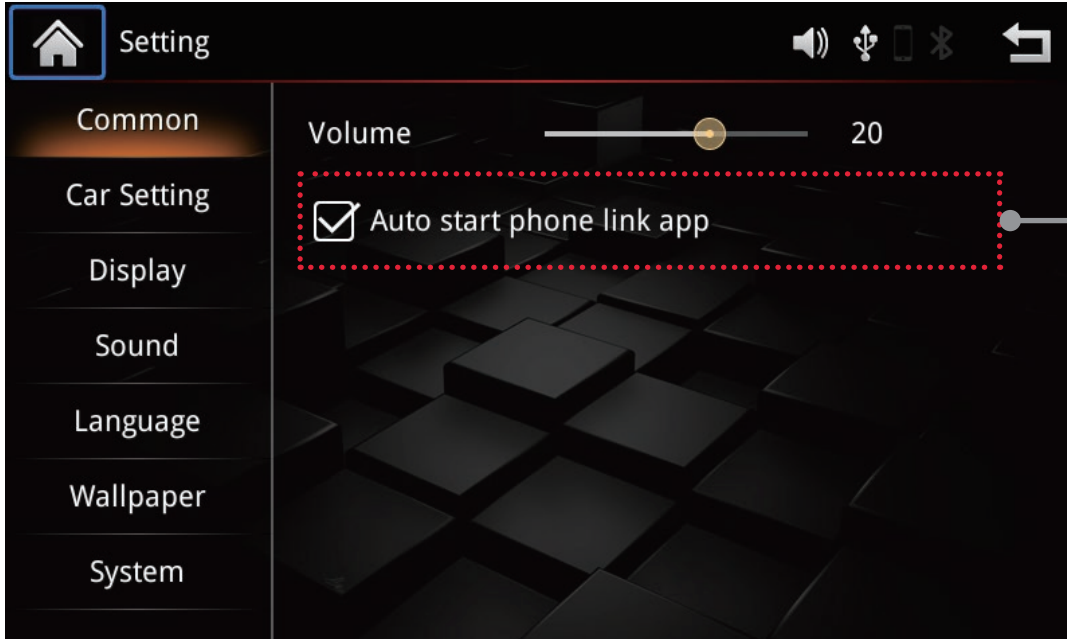

Select "**Settings**" on main menu and tick "**Auto start phone link app**". Then CarPlay and Android Auto will start automatically after connecting your iPhone or Android smartphone.

- **CAR SETTING**

AMP function is not available, turn it off by default.

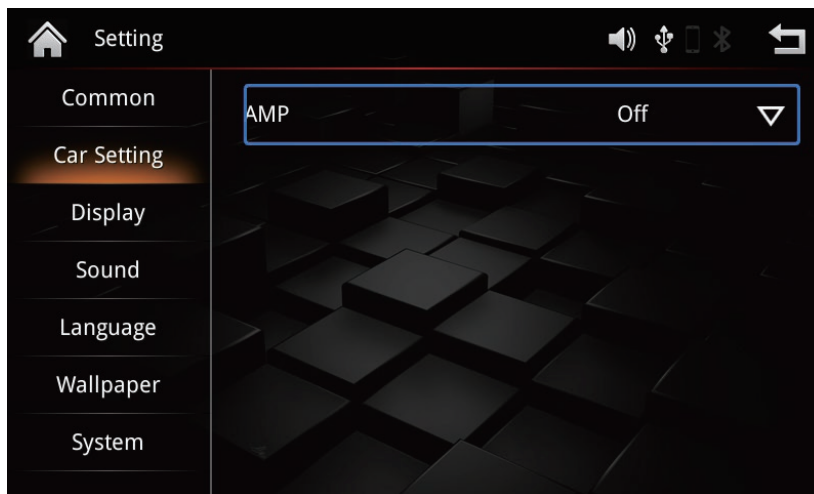



## ● TOUCH CALIBRATION

After installing a resistive touch panel, press and hold the panel more than 10s, it will enter touch calibration.

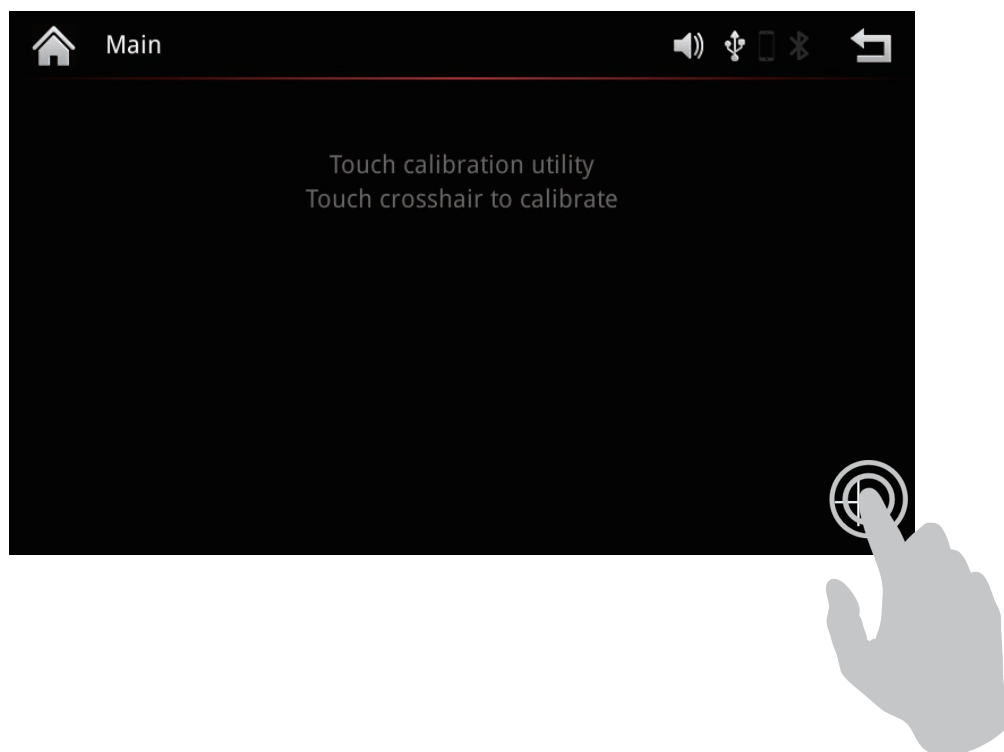

## ● DISPLAY

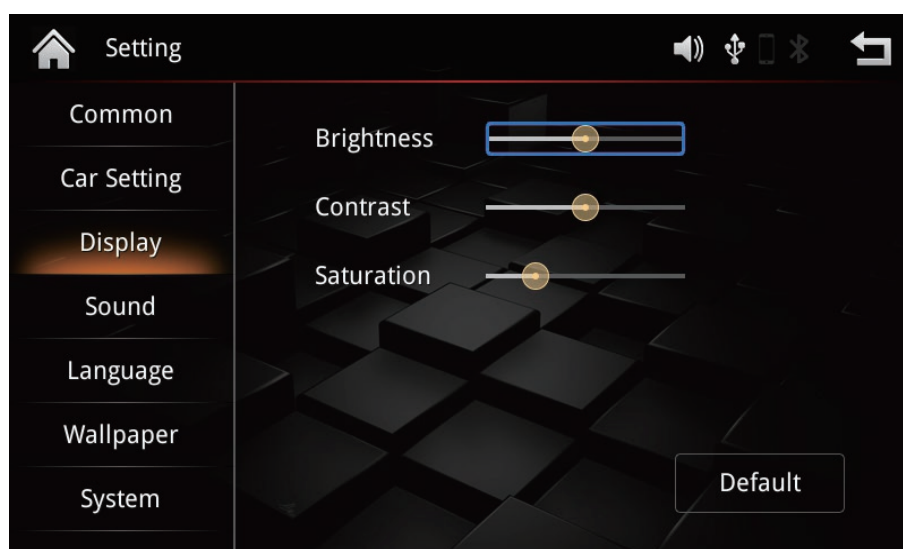

# ● SOUND

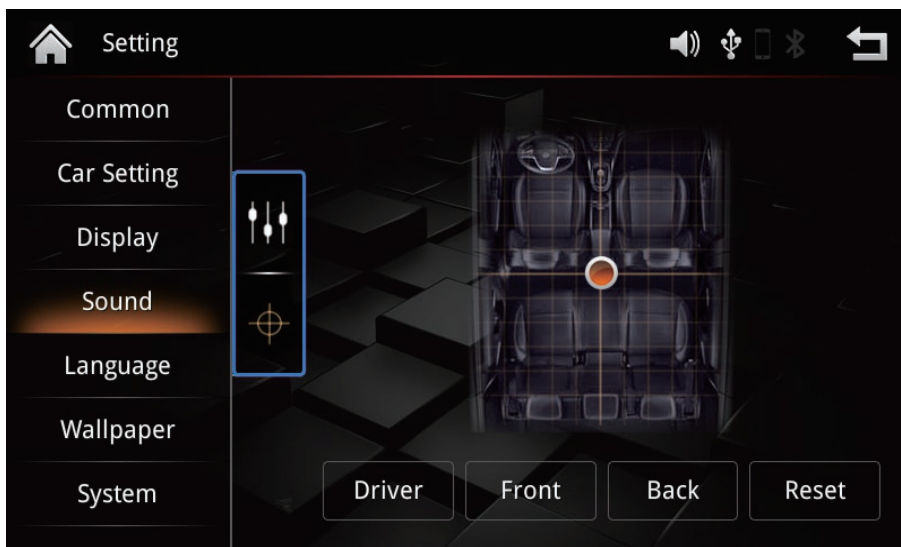
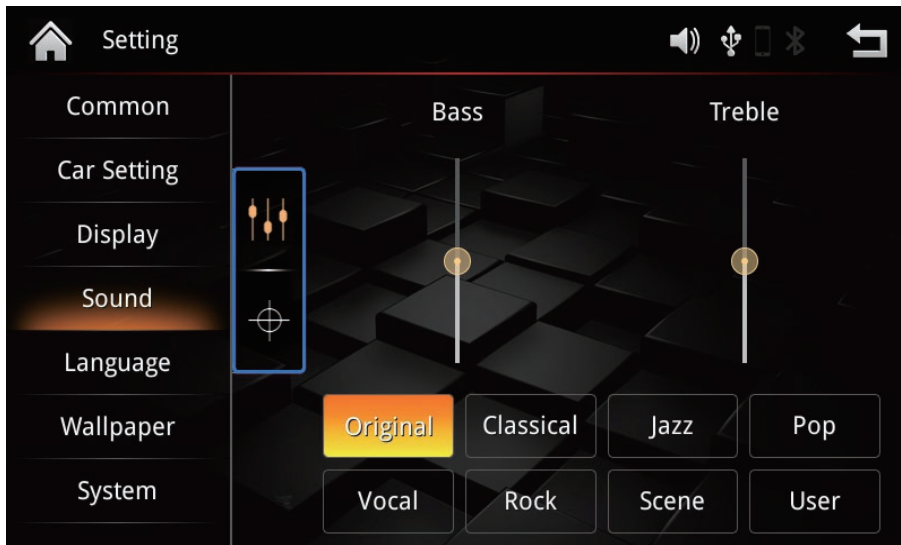
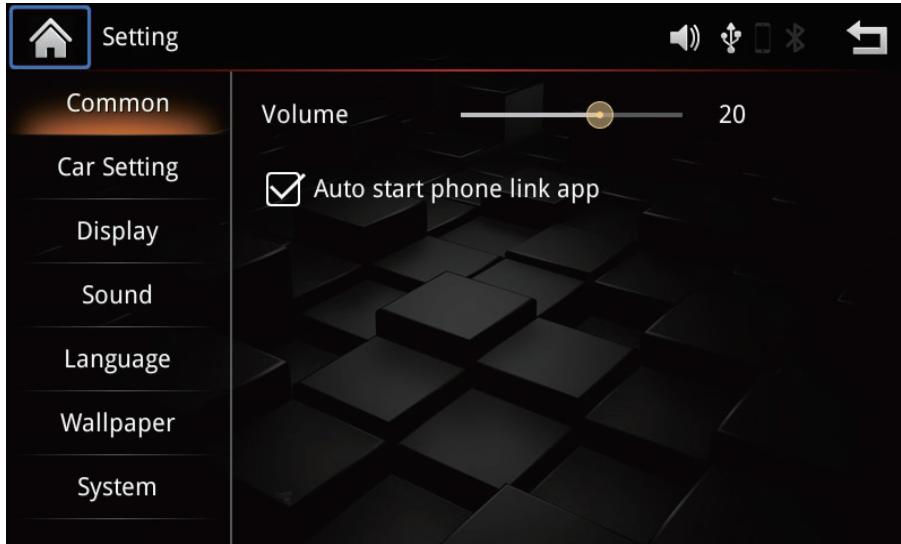



## ● LANGUAGE



## ● WALLPAPER

